

Safety **1st**[®]

Guide 65

5-65 pounds (2.3-29 kg) 19-52 inches (48-132.1 cm)



See our full line of crash tested accessories at
www.safety1st.com

Safety **1st**[®]

**KEEP INSTRUCTIONS
FOR FUTURE USE.**
Read all instructions before
using this child restraint.



⚠ WARNING:

**Failure to follow the warnings on the labels and
in the instruction manual can result in serious
injury or death to your child.**

4358-5721



© 2011 Dorel Juvenile Group All Rights Reserved.

A. Before You Begin.....Pages 3-8

- A-1 Registration and Safety Notices
- A-2 Understanding Your Child Restraint

D. General Vehicle InstallationPages 28-36

- D-1 Understanding Your Vehicle
- D-2 Vehicle Seating Position
- D-3 Choosing LATCH or Vehicle Belts
- D-4 Knowing Your Vehicle Belts
- D-5 Using Locking Clip
- D-6 Installing on Aircraft

B. Safety Information..... Pages 9-10

- B-1 Vehicle Seating Position
- B-2 Installation in Vehicle
- B-3 Child Restraint Use

E. Installing Rear-Facing..... Pages 37-44

- E-1 Preparing to Install Rear-Facing
- E-2 Preparing to Install LATCH Rear-Facing
- E-3 Install Rear-Facing with LATCH
- E-4 Install Rear-Facing with Vehicle Belts



C. Basic UsePages 11-27

- C-1 Choose Position for Your Child
- C-2 Preparing Child Restraint to Fit Your Child
- C-3 Securing Child in Child Restraint
- C-4 Removing Child From Child Restraint
- C-5 Accessories
- C-6 Reclining Child Restraint
- C-7 Removing Harness System
- C-8 Installing Harness System
- C-9 Removing Pad for Cleaning

F. Installing Forward-Facing Pages 45-53

- F-1 Preparing to Install Forward-Facing
- F-2 Adjusting Top Anchorage Strap (Tether)
- F-3 Preparing to Install LATCH Forward-Facing
- F-4 Install Forward-Facing With LATCH
- F-5 Install Forward-Facing with Vehicle Belts



A-1 Thank You...

Thank you for choosing this car seat, referred to throughout this manual as a child restraint. The DJG family is committed to creating a child restraint with the most comfort and convenience available today.

Remember, parents are a child's first teachers and examples. If you always buckle your seat belt, your child will think it is the natural thing to do. Make it a firm rule that the vehicle does not go until everyone is buckled up. Make no exceptions.

No one can predict if use of a child restraint will prevent injury or death in a particular crash. However, combined with careful driving, proper use of a child restraint can lower a child's risk of injury or death in most crashes.

Your child's safety is worth the time it will take to read and follow these instructions. After reading, if you still have questions or have any problems with this child restraint, please contact our Consumer Relations Department at:

Dorel Juvenile Group, Inc.

Website: www.djgusa.com
 Fax: 1-800-207-8182
 Mailing Address: Dorel Juvenile Group, Inc.
 P.O. Box 2609
 Columbus, IN 47202-2609
 Telephone: 1-800-544-1108
 7 A.M. to 6 P.M. EST M-TH
 7 A.M. to 4:30 P.M. EST FRI

On the back of the plastic shell there is an expiration date for use of this child restraint. Do not use this child restraint after the expiration date.

Para recibir las instrucciones en español, llame al 1-800-544-1108 o solicítase por escrito al dirección por arriba.

A-2 Registration and Safety Notices

Please complete the postage-paid registration card that came with your child restraint, and send it to us. Child restraints could be recalled for safety reasons. You must register this restraint to be reached in a recall. Send your name, address, email address if available, and the restraint's model number and manufacturing date to:

Dorel Juvenile Group, Inc.
 PO Box 2609, Columbus, IN 47202-2609
 Attn: Consumer Relations

or call 1-800-544-1108 or register online at www.djgusa.com/registration/carseat/us.

For recall information, call the U.S. Government's Vehicle Safety Hotline at 1-888-327-4236 (TTY: 1-800-424-9153), or go to <http://www.NHTSA.gov>

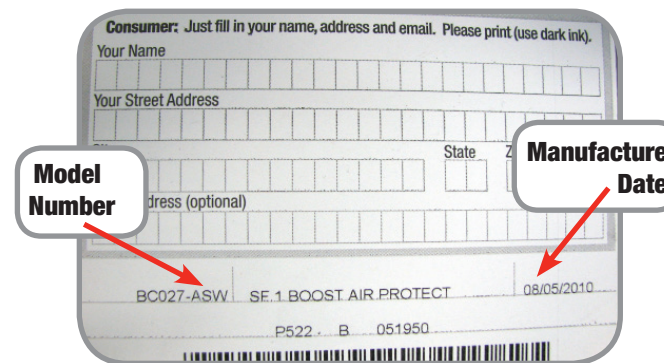

If you don't have the card or if your address changes, you will find the model number and manufactured date on the label located on side of plastic shell.



A-3 Understanding Your Child Restraint

Front View

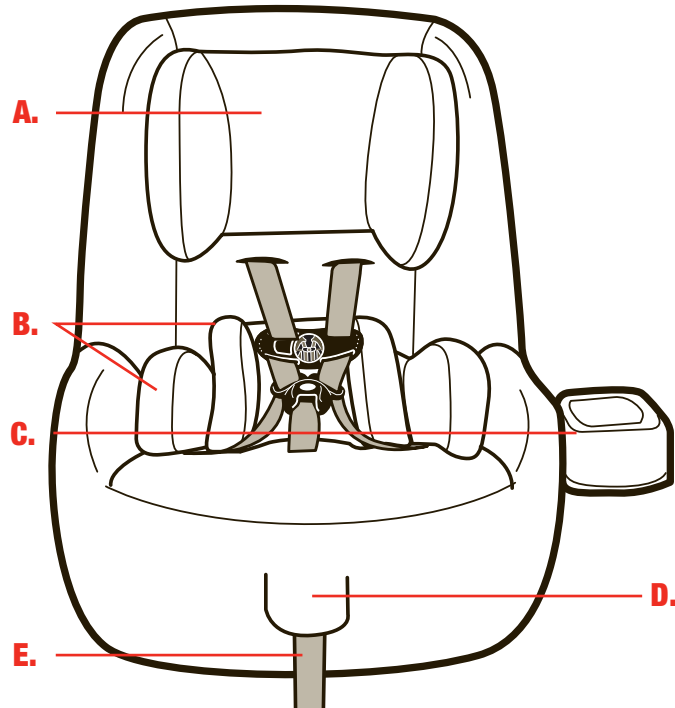

- A. Adjustable Headrest**
- B. Body Pillows**
(on select models)
- C. Cup Holder**
(on select models)
- D. Harness Release Lever** (under flap)
- E. Harness Tightening Strap**

5

Harness System Detail

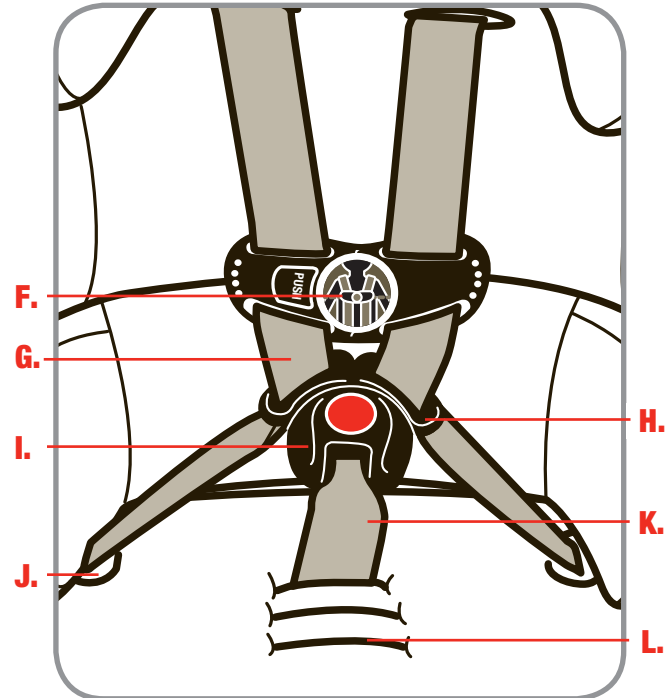

- F. Chest Clip**
- G. Harness Straps**
- H. Buckle Tongue**
- I. Buckle**
- J. Harness Guides**
- K. Buckle Strap**
- L. Buckle Strap Slots**

A. Before You Begin

6

continued on next page.

Back View

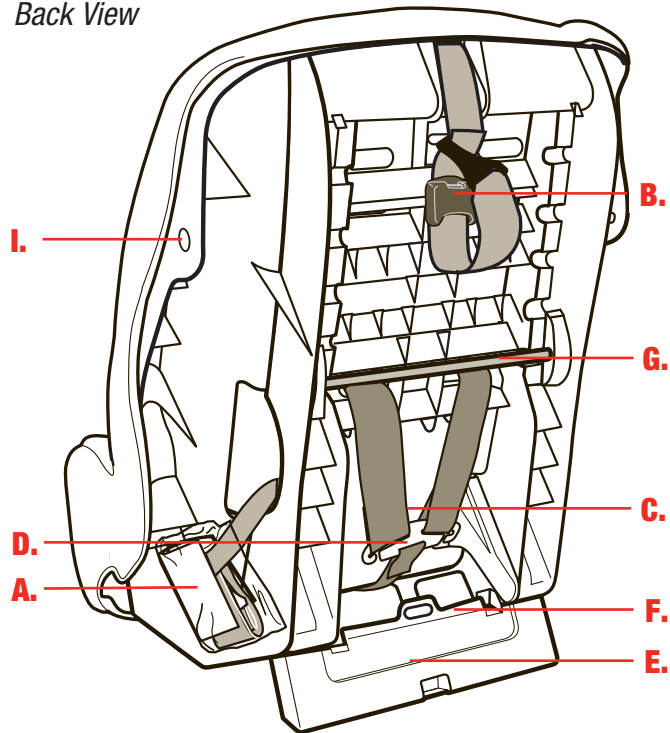

- A. LATCH Belt**
- B. Top Anchorage Strap (Tether)**
- C. Locking Clip**
(behind harness)
- D. Splitter Plate**
- E. Recline Stand**
- F. Instructions**
(in recline stand)
- G. Headrest Adjustment Bar**

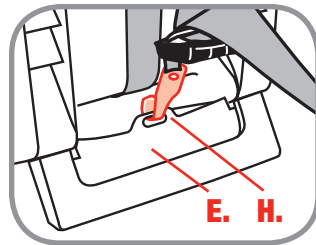

- H. Top Anchorage Hook (Tether) Storage**
- I. LATCH Storage**

Side View

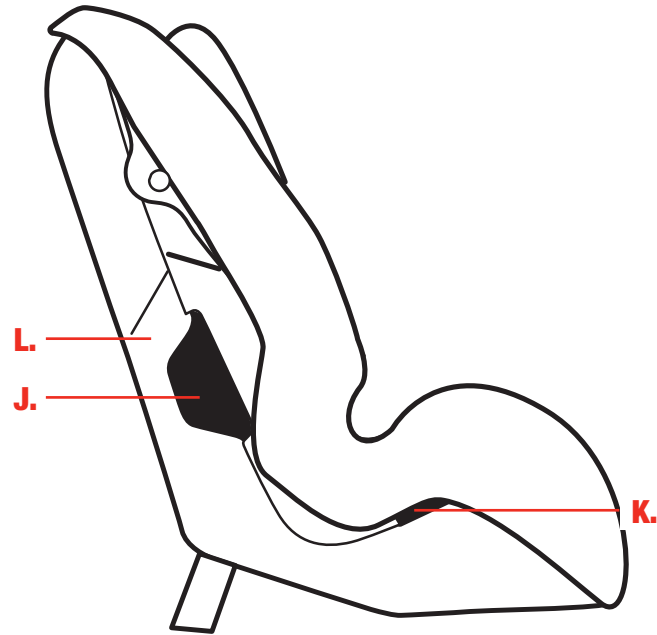

- J. Forward-Facing Belt Path**
- K. Rear-Facing Belt Path**
- L. Level to Ground Lines**
(on side of plastic shell)

A. Before You Begin

⚠ WARNING:

Failure to follow these warnings can result in the serious injury or death of your child. To help you recognize instructions which are most critical to your child's safety, we use this symbol: ⚠

B-1 Vehicle Seating Position



⚠ Never place a child rear-facing in a seating position with an active frontal airbag.

⚠ Check the vehicle owner's manual for more information about air bag/child restraint use.

⚠ For vehicles without a back seat, refer to your vehicle owner's manual.

B-2 Installation in Vehicle

⚠ Check the vehicle belt or LATCH belt before each use. Use only if the belt is tightened properly and securely.

⚠ This child restraint should be securely belted in the vehicle even when not in use. In a crash or sudden stop, an unsecured child restraint could injure occupants.

⚠ Do not use a child restraint that has been in a crash. You must get a new child restraint.

B-3 Child Restraint Use

⚠ Never take your child out of the child restraint while the vehicle is moving. Never leave child unattended.

⚠ Placing your child in a hot child restraint may result in burns.

⚠ Do not use a child restraint with damaged or missing parts.

⚠ Do not use cut, frayed or damaged harnesses.

⚠ Do not lubricate buckles and fasteners.

⚠ Do not substitute parts or try to modify the child restraint in any way.

⚠ Do not use any child restraint accessory except those approved by Dorel Juvenile Group.

⚠ Never allow any child to play with this child restraint; it is not a toy.

⚠ Do not remove or cover up any of the warning labels or other labels on the child restraint.

⚠ Read all instructions for additional warnings.

G-1 Choose Position for Your Child

Your child's height, weight and age determine how your child restraint should be placed in the vehicle.



**5-40 lbs (2.3-18 kg)
and 19-40 in. (48-101.6 cm)**

Rear-Facing using 5-point harness

Child and child restraint are placed in the back seat, facing the back of the vehicle.

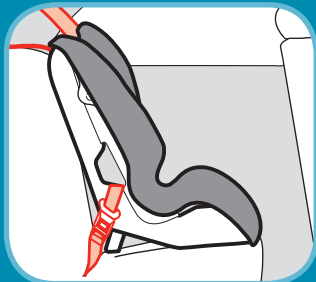

**22-65 lbs (10.1-29 kg)
and 34-52 in.
(85.1-132.1 cm) and
Over 1 Year Old**

Forward-Facing using 5-point harness

Child and child restraint are placed in the back seat, facing the front of the vehicle.

G-2 Preparing Child Restraint to Fit Your Child

Make these adjustments with your child in the child restraint before you install in the vehicle.

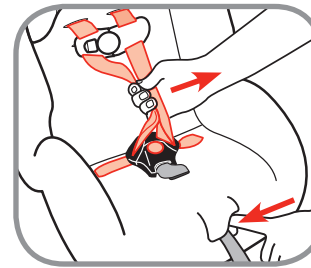

1. Loosen Harness

Push down on the harness release lever (under flap on the front of child restraint) while pulling out on the harness straps just above the buckle.

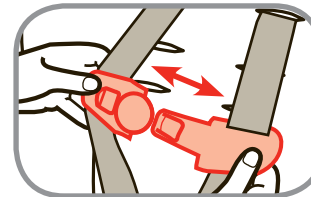

2. Release Chest Clip

Press on chest clip release button and pull apart.

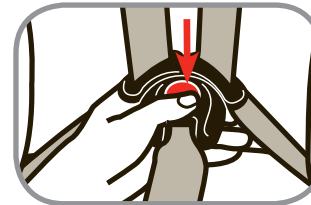

3. Unbuckle Harness

Press red button. Pull buckle tongues out. Place harness straps out of the way.

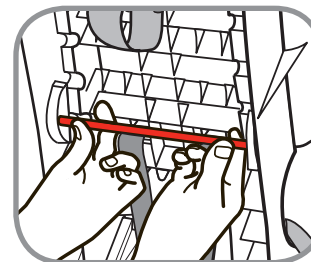

4. Lift Headrest to the Highest Position

Pull out on the metal bar on the back of the seat and slide the headrest all the way up. This will expose all harness slots.



5. Place Child in Child Restraint

Place the child's bottom and back flat against the child restraint. This will increase comfort and allow the harness straps to be properly tightened.

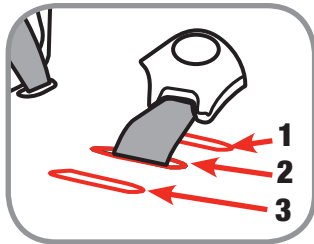

6. Check Buckle Position

Determine which of the available buckle positions will be comfortable and provide a snug fit for your child.

You MUST use the 1st or 2nd buckle strap slots when rear-facing. Any slot can be used for forward-facing.

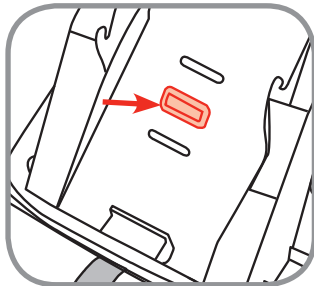

To Change Buckle Position

a. Remove your child. Flip the child restraint over and locate buckle's metal retainer.

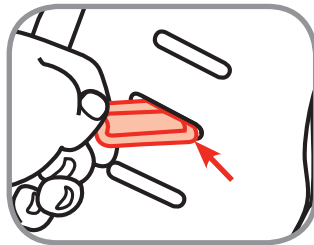

b. Rotate metal retainer, then insert retainer up through the plastic shell and pad.

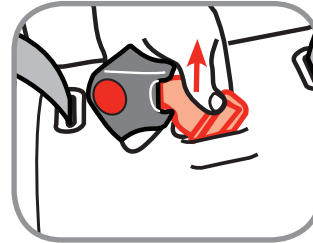

c. From the top, pull buckle free from plastic shell and pad.

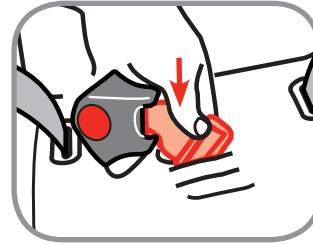

d. Reposition buckle location. Insert the buckle's metal retainer through the desired slot. Make sure buckle is facing forward.

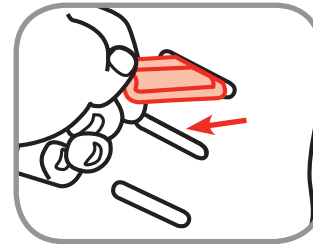

e. Pull buckle's metal retainer **completely through pad and plastic shell.**

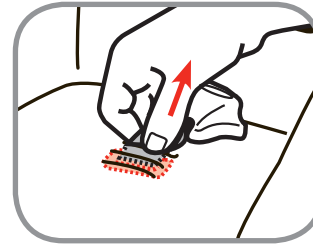

f. Pull up on buckle to make sure it is secured. **The buckle must not pull out.**

⚠ WARNING:

Failure to place buckle's metal retainer completely through pad and plastic shell can result in serious injury or death.



7. Check Harness Height

With child in the child restraint, check the location of the harness slot.

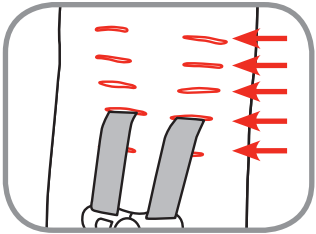

8. Choose the Correct Harness Slot That Fits Your Child

Follow the guidelines below to determine the correct harness height.

NOTE: The upper most harness slot may be behind the headrest pad.



Rear-Facing Position

Harness slot must be **even with or just below** the shoulders.

If the lowest harness slot is above the child's shoulders, **do not** use this child restraint.



Forward-Facing Position

Harness slot must be **even with or just above** the shoulders.

If the highest harness slot is below the child's shoulders, **do not** use this child restraint.

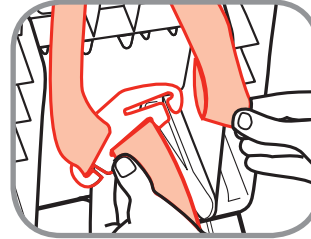

9. To Change Harness Location

From the back of the seat, remove harness from splitter plate.

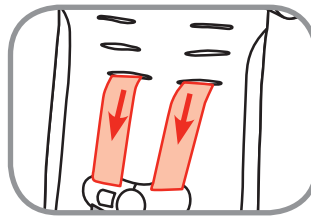

10. Pull Harness Out of Shell From the Front

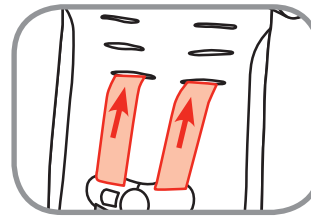

11. Rethread Harness Into Correct Harness Location

Make sure harness does not twist.

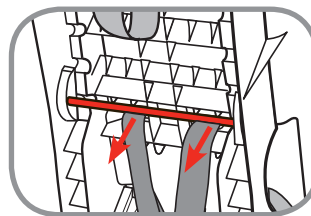

12. Pull Harness Through Pad and Shell

Make sure metal headrest bar is above the harness straps.

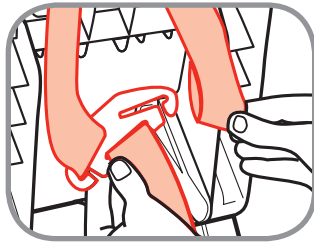

13. Slip Harness Straps onto Splitter Plate

Attach the both harness straps end to the splitter plate. Make sure that the harness straps do not twist.



14. Position Headrest

Place child in the child restraint. Position the headrest behind the child's head. Make sure the metal bar is locked into position and above the harness straps.

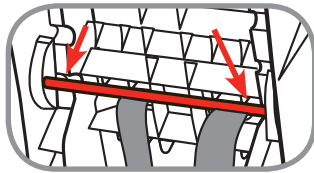

⚠ WARNING:



Do not use this child restraint rear-facing if the top of your child's head is above the top of the child restraint's headrest.



Do not use this child restraint forward-facing if the midpoint of your child's head is above the top of the child restraint's headrest.

Make sure the harness height is correct for your child's size.

Failure to follow these steps can result in serious injury or death.

C-3 Securing Child in Child Restraint



1. Position Harness Straps Over the Child's Shoulders.

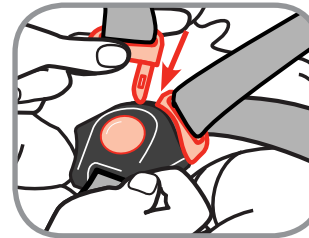

2. Buckle Harness

Push each buckle tongue into buckle until you hear a "click". Remember to always pull up on harness straps to make sure buckle is locked.

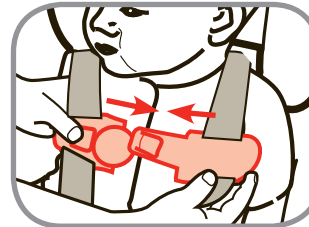

3. Close Chest Clip

Insert right half of chest clip into left half and snap together.

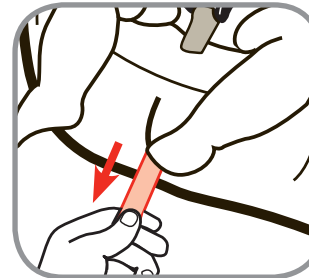

4. Tighten Harness

Pull on harness tightening strap to tighten harness snugly.

NOTE: A snug strap should not allow any slack. It lies in a relatively straight line without sagging. It does not press on the child's flesh or push the child's body into an unnatural position.

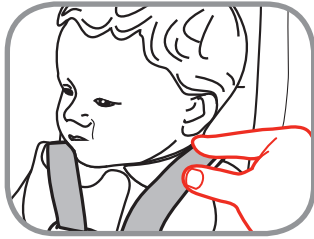

5. Check Harness Tightness

Try to pinch the harness at the shoulders. If you can pinch the harness strap, tighten more. If your fingers slip off, the harness is tight enough.



6. Position Chest Clip

The chest clip must be placed at mid-chest (even with armpits) and away from the child's neck.

⚠ WARNING:
Failure to fasten and tighten the harness system correctly and snugly can result in serious injury or death.

C-4 Removing Child From Child Restraint

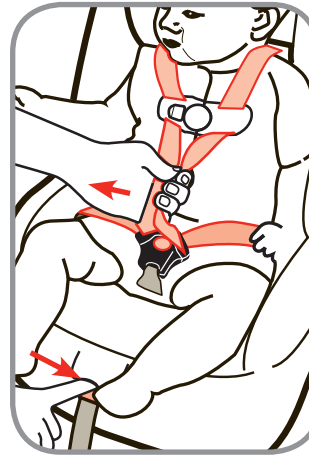

1. Loosen Harness

Press on harness release lever while pulling on harness straps above the buckle to loosen.

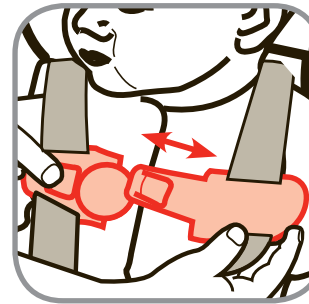

2. Release Chest Clip

Press on release button and pull apart.

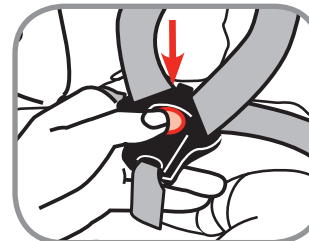

3. Unbuckle

Press red button on buckle to release the buckle tongues. Move harness away and remove child.

C-6 Reclining Child Restraint

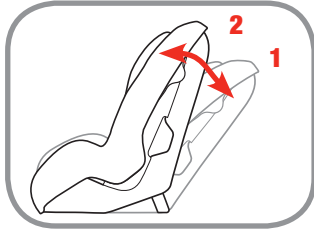

Rear-facing - 1 Must be fully reclined.

Forward-Facing - 2 Must be upright.

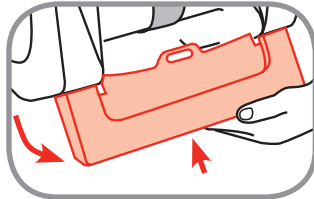

Upright

Rotate recline stand out and push upward to lock in position.

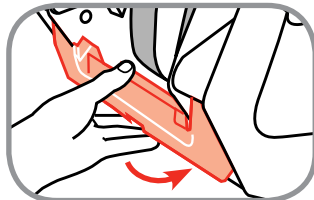

To Recline

Pull recline stand down and rotate under child restraint.

C-5 Accessories

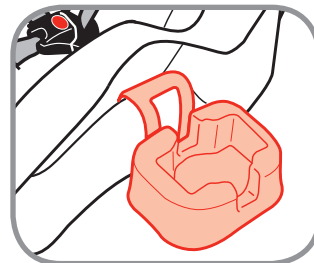

Install Cup Holder (on select models)

Pull pad off corner. Hook bottom of cup holder to edge of plastic shell.

Rotate cup holder up until it snaps into the hole on the plastic shell. Replace pad. Cup holder can be on either side.



21

C-7 Removing Harness System

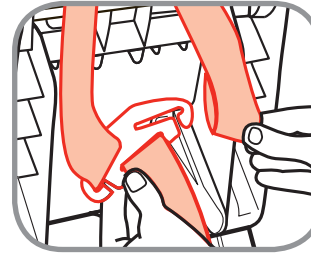

1. Remove Harness Straps from Splitter Plate

Fully loosen harness straps. Locate splitter plate on the back of the child restraint and unfasten the harness straps.

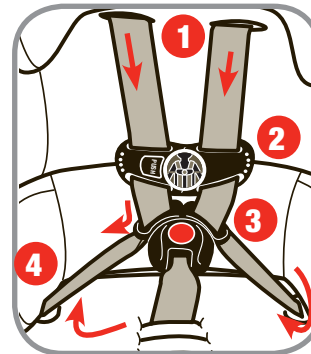

2. Remove Harness Straps

Pull harness through the slots from the front (1).

Unthread harness from the chest clip (2).

Unthread harness from the buckle tongues (3).

Pull harness out of plastic shell (4).

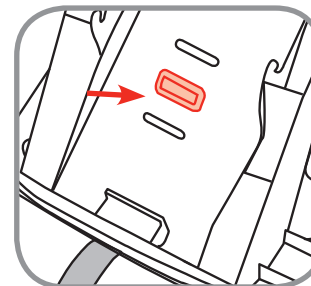

3. Remove Buckle

Flip the child restraint over and locate buckle's metal retainer.

22

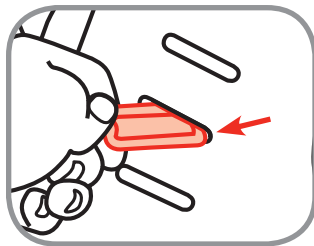

4. Rotate metal retainer, then insert retainer up through the plastic shell and pad.

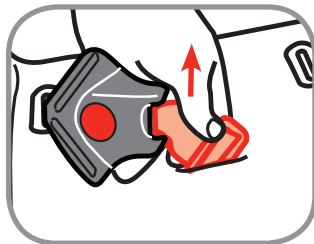

5. From the top, pull buckle free from plastic shell and pad.

C-8 Removing Pad for Cleaning

You must remove the harness system to remove the pad on the plastic shell.

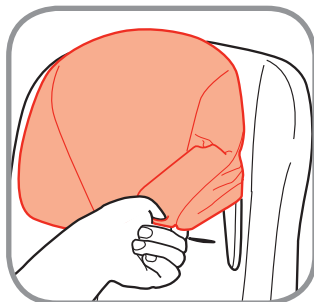

1. Remove Headrest Pad

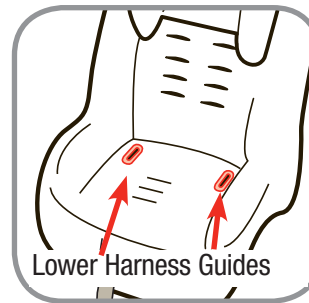

2. Remove Lower Harness Guides (on select models)

Remove both lower harness guides (A) in bottom of child restraint under recline stand.

Push harness guide lip toward outside of plastic shell with one hand while pulling harness guide from the front with the other.

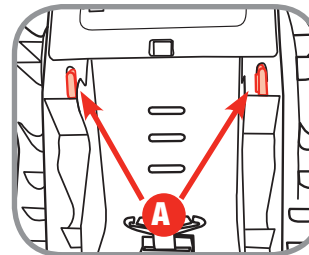

3. Remove Upper Harness Guides (on select models)

Push down on one edge with one hand while pulling out on the harness guide from the front with the other hand.

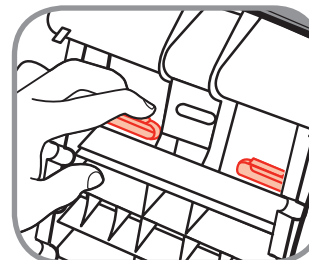

4. Remove the Elastic Straps from Bottom of Child Restraint

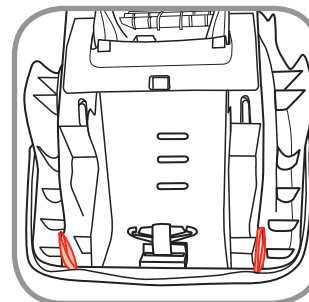

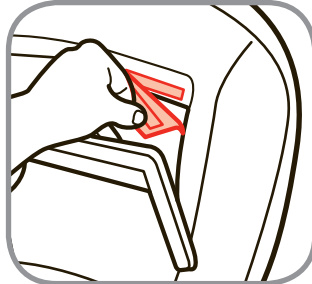

4. Undo Fasten Strip Behind Headrest

Lower headrest to lowest position and undo the fastening strip behind the headrest. Pull back pad down from behind the headrest.

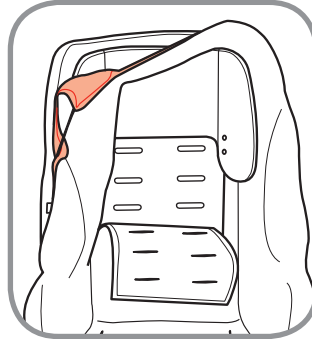

5. Remove Seat Pad

Pull pad off the top of child restraint and around headrest.

Cleaning Pad

Hand wash pad with warm sudsy water, rinse clean and air dry. Spot clean the harness straps. Do not use bleach or use other harsh cleaners. Do not dry clean.

⚠ WARNING:
Do not use child restraint without the pad.

Replace child restraint pad by reversing order; Starting from bottom of child restraint, slip pad on plastic shell; pull harness tightening strap through pad. Make sure pad is under headrest and attach the fastening strip behind the headrest. Replace lower and upper harness guides. Replace headrest pad.

Attach all of the elastic straps.

Rethread harness (see section C-9).

C-9 Installing Harness System

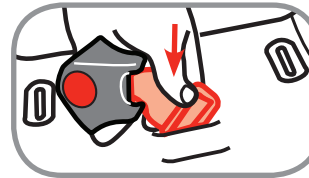

1. Install Buckle

Fit the buckle's metal retainer through the slot in the child restraint. Red button must face out.

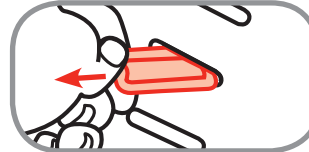

Pull buckle's metal retainer **completely through pad and plastic shell** from bottom of child restraint.

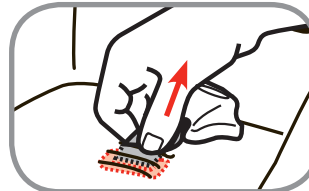

2. Check Buckle

Pull up on buckle to make sure it is secured. **The buckle must not pull out.**

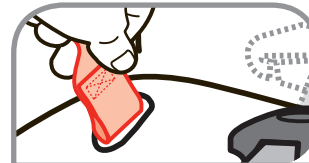

3. Thread Harness Strap

Thread the harness down through slot on left side of plastic shell (1) and up through slot on right side (2).

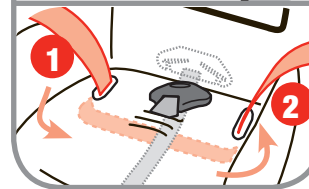

NOTE: Make sure sewn end of the harness strap loop faces the buckle before starting.

Take both ends of the harness and make them even in length.

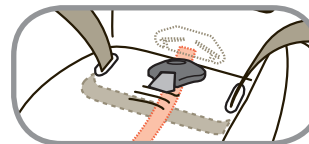

NOTE: Make sure harness tightening strap is between the harness strap and plastic shell as shown.

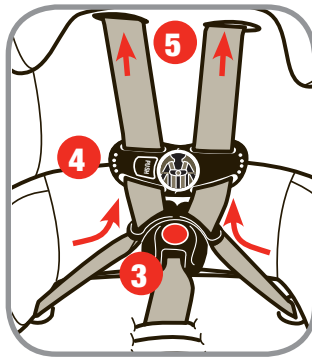

4. Thread harness straps through each buckle tongue (3). Thread the chest clip (4). Do the same to the other harness end. **Do Not twist harness.**

Push harness ends through slots in headrest (5).

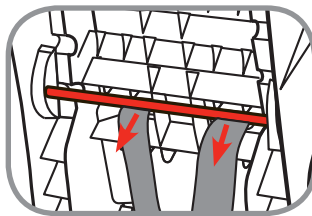

5. Pull Harness Through Pad and Shell

Make sure the metal bar is above the harness straps.

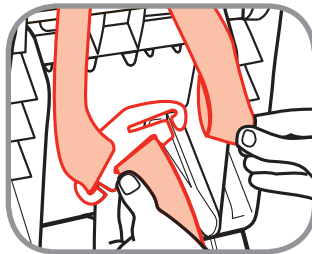

6. Attach Harness Straps to Splitter Plate

Fit loops on harness ends **completely** on the splitter plate.

NOTE: Make sure sewn end of the harness strap loop faces towards you.

⚠ WARNING:

Harness MUST be threaded under the metal bar. Harness system must be reattached correctly. Failure to follow these warnings can result in serious injury or death.

D-1 Understanding Your Vehicle

Your vehicle's features may be considerably different than those pictured here. Consult your vehicle owner's manual to help identify your vehicle's specific features and locations.

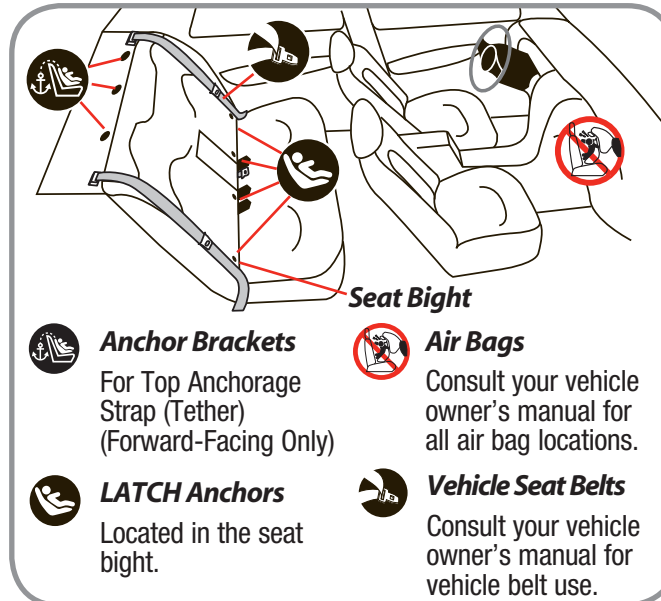

Anchor Brackets

For Top Anchorage Strap (Tether)
(Forward-Facing Only)



LATCH Anchors

Located in the seat bight.



Air Bags

Consult your vehicle owner's manual for all air bag locations.



Vehicle Seat Belts

Consult your vehicle owner's manual for vehicle belt use.

Safety Tip:

To help protect your vehicle seat's upholstery from damage, use a single layered towel underneath and behind child restraint.

To avoid your child being seriously burned, take the following precautions:

1. Park in the shade or where sun does not directly hit the child restraint.
2. Cover the child restraint with a sheet or blanket when not in use.
3. Check for hot child restraint and buckles before placing child in child restraint.

D-2 Vehicle Seating Position

Some seating positions in your vehicle may not be safe for this child restraint. Some vehicles do not have a seating position that can be used safely with this child restraint. If you are not sure where to place the child restraint in your vehicle, consult your vehicle owner's manual or contact Dorel Juvenile Group Consumer Relations Dept.

⚠ WARNING:



Never place a child rear-facing in a seating position with an active frontal airbag. This can result in serious injury or death.

⚠ WARNING:



Use the child restraint only on vehicle seats that face forward. Do not use on seats that face the sides or rear of the vehicle.



Safety Tip:



Children are safer when properly restrained in rear seating positions than in the front seating positions.

According to National Highway Traffic Safety Administration information, children in rear seating positions are statistically safer, whether you have air bags, advanced air bags, or no air bags at all.

D-3 Choosing LATCH or Vehicle Belts

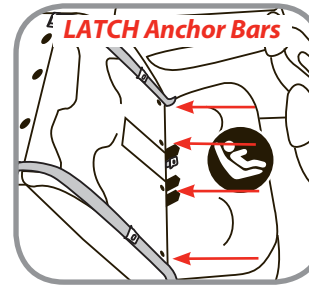

The LATCH System

LATCH (Lower Anchors and Tethers for CHildren) is a universal system for installing child restraints without using vehicle seat belts.

The LATCH system can ONLY be used in vehicles that have the LATCH anchor bars installed and designated LATCH seating positions. Most vehicles manufactured after September 2002 are equipped with LATCH.

Check your vehicle owner's manual to see which seating positions may be equipped with the LATCH system.

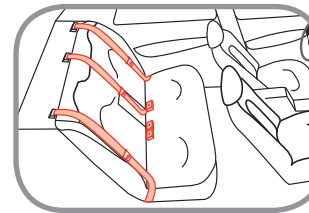

Vehicle Belts

If LATCH is not an option, you must use the vehicle seat belt system to install the child restraint. There are some vehicle belts that will not work with a

child restraint or will require special attention.

See next page and check your vehicle's owner's manual for specific instructions.

⚠ WARNING:

Do not use both the LATCH belt and vehicle belt at the same time.

D-4 Knowing Your Vehicle Belts

Review your vehicle's owner manual for vehicle seat belt use with child restraints. This is your best source for information concerning your vehicle.

Not all vehicle belts will work with this child restraint. This child restraint must be tightly locked in place at all times, during travel. You must determine if your vehicles belts are compatible with this child restraint.

Vehicle Belts

• Automatic/Passive vehicle seat belts

You **MUST** have a vehicle lap belt to install any child restraint. An automatic (passive) shoulder vehicle belt may or may not have a separate vehicle lap belt. Consult your vehicle owner's manual.



• Vehicle belts in center of the door or side panel

You must move the child restraint to another seating location. Consult your vehicle owner's manual.

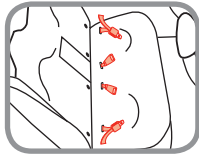

• Vehicle belts that are in front of the seat bight

You may need to move the child restraint to another seating location. Consult your vehicle owner's manual.

• ELR (Emergency Locking Retractor) vehicle belts

These lap and shoulder vehicle belts only lock in a sudden stop or crash, and do not properly secure a child restraint alone. Consult your vehicle owner's manual.

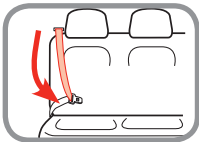

To learn if you have this type of vehicle belt, gently pull the vehicle belt all the way out of the retractor (spool), let it return several inches, then pull on it again. If it moves freely, it is an ELR vehicle belt. If it is locked and will not allow any more vehicle belt to come out, it is a switchable retractor.

⚠ WARNING:

ELR lap-only vehicle belts MUST NOT be used with this child restraint.

• Switchable retractor

These vehicle belts switch from ELR to ALR (Automatic Locking Retractor). You must have the vehicle belts in the locking mode to use them. Follow the instructions in the installation sections.

• ALR (Automatic Locking Retractor)

These vehicle belts lock after pulling the webbing out and letting the vehicle belt go back into the retractor an inch or two. Follow the instructions in the installation sections.

Vehicle Latch Plates

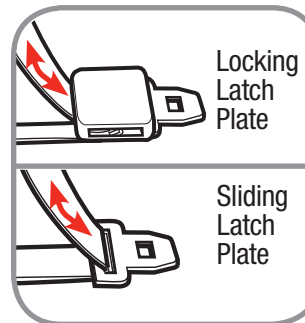

• Check the Latch Plates

Grasp the tongue portion of the latch plate (the part that goes inside the buckle) and pull straight out, in line with the vehicle lap belt. If the latch plate does not slide up and down the vehicle belt, you have a locking latch plate. You should not need to use a locking clip. Consult your vehicle owner's manual.

If the latch plate slides up and down on the vehicle belt, and you have an ELR retractor, you **MUST** use a locking clip to install the child restraint. You may not need to use the locking clip with a switchable or ALR retractor. Consult your vehicle owner's manual.

D-5 Using the Locking Clip

A locking clip will not fix all types of vehicle seat belt problems. Review section D-4 and your vehicle's owner manual for vehicle seat belt use with child restraints. The locking clip is located on the back of the child restraint.

The following directions describe installing the child restraint rear-facing. Same steps apply for forward-facing, except install the restraint forward-facing and thread the vehicle belt in the forward-facing belt path.

⚠ WARNING:

Do not use both the LATCH belt and vehicle belt at the same time.



1. Place Child Restraint in Vehicle Rear-Facing

With child restraint in the most reclined position, place child restraint in the back seat.

Check for proper recline.

NOTE: Store top anchorage hook (tether) on the base. See section E-1.

For children between 5-22 lbs (2.3-10 kg), the bottom level to ground line **MUST** be level to the ground.

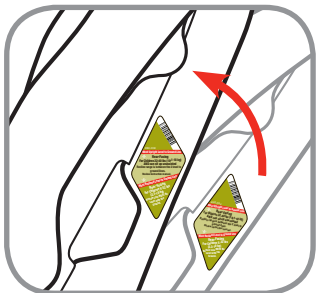

For children 22-40 lbs (10.1-18 kg) and can sit up unassisted, rotate the child restraint between the 2 level to ground lines. Start by making the bottom level to ground line level, then rotate seat up. **DO NOT** rotate past the top most upright level to ground line.

Adjust child restraint if needed.

33

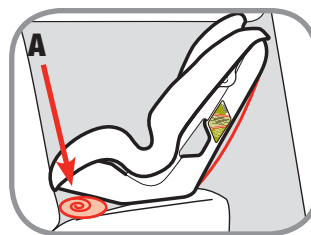

You may need to place a large rolled towel(s) or foam pool noodle(s) **(A)** under the front of the child restraint to help achieve the correct recline. Check often to be sure padding is still in place and the vehicle belt is tight.

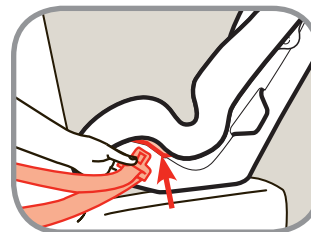

2. Thread Vehicle Belt

Thread the vehicle lap/shoulder belt combination through the rear-facing belt slot.

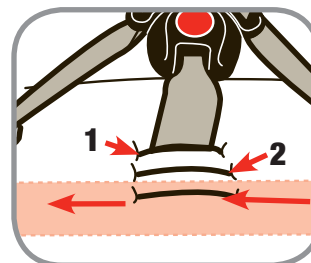

3. Pull Vehicle Belt Across Child Restraint

Thread vehicle seat belt **under** pad in front of buckle strap to the opposite side. Buckle vehicle belt.

Do not place vehicle belt over child's legs.

NOTE: The buckle **MUST** be in the 1st or 2nd buckle strap slots when rear-facing. Any slot can be used for forward-facing.

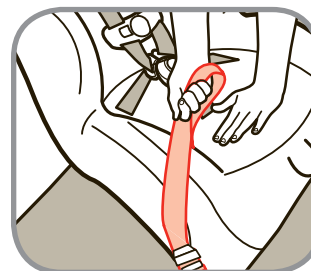

4. Tighten Vehicle Belt

Push down firmly on the child restraint and while pulling on the vehicle shoulder belt to tighten.

34

continued on next page.

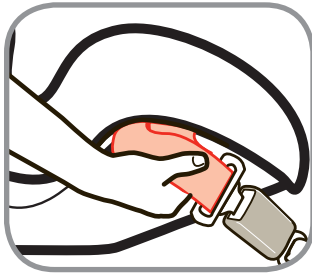

5. Locate Locking Clip Location

Grasp both vehicle belts together just behind the latch plate and unbuckle. **NOTE:** If the latch plate ends up just at the belt path opening, grasp the vehicle belts on the opposite side of the child restraint, as close to the latch plate as possible.

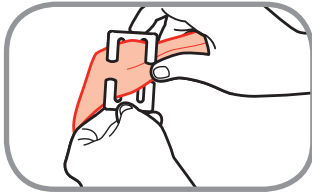

6. Attach Locking Clip

Thread both portions of the vehicle belt onto the locking clip, as close to the latch plate as possible.

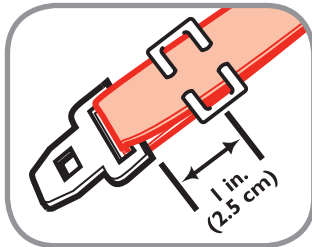

7. Position Locking Clip

Position locking clip about 1 in. (2.5 cm) from vehicle belt's latch plate.

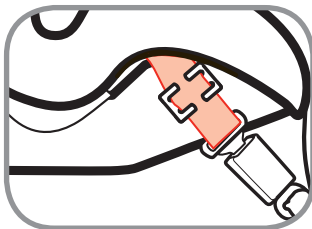

8. Rebuckle Vehicle Belt

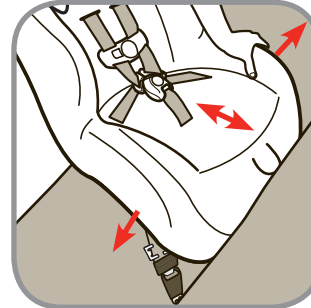

9. Check Vehicle Belt Tightness

Grasp the child restraint at the vehicle belt path with one hand. Push and pull the child restraint from side to side, forward and back. The child restraint should not move more than 1 inch.

NOTE: If it moves more than an inch, redo the steps 5 through 9 again or try another seating location.

Recheck the recline angle to make sure it is reclined according to your child's weight. Repeat steps if not reclined correctly.

Remove the locking clip when the vehicle seat belt is not being used with a child restraint.

D-6 Installing on Aircraft



This restraint is certified for aircraft use.

Use only on forward-facing aircraft seats. Follow instructions for vehicle installation.

Contact the airline for their specific policies.

E-1 Preparing to Install Rear-Facing

5-40 lbs (2.3-18 kg) and 19-40 in. (48-101.6 cm)
Rear-Facing using 5-point harness



 LATCH Belt



 Lap/Shoulder Belt



 Lap Belt

⚠ WARNING:

 **Never place a child rear-facing in a seating position with an active frontal airbag. This can result in serious injury or death.**

This child restraint must always face the rear of the vehicle and be in the fully reclined position when the child is less than one year old.



E-2 Preparing to Install LATCH Rear-Facing

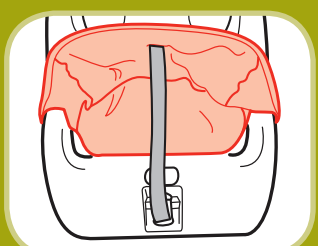

1. Pull Pad Off Corners of Child Restraint

Pull the pad off the front corners of plastic shell.

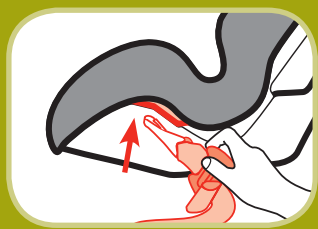

2. Routing LATCH Belt

Insert the hook with adjuster through the rear-facing belt path.

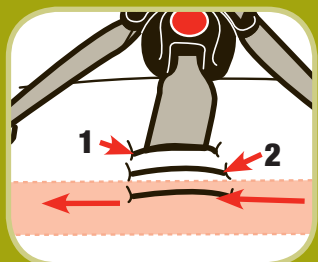

3. Pull Hook Across to Opposite Side

Reach under pad and pull the LATCH hook across the plastic shell. LATCH belt **MUST** be under pad and in front of buckle strap.

NOTE: You must use the 1st or 2nd buckle strap slots when rear-facing.

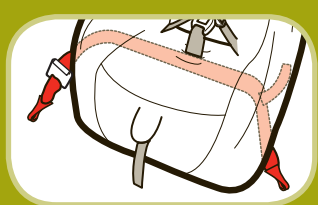

4. Replace Pad Over Corners

Make sure the LATCH belt is not twisted.



E-3 Install Rear-Facing with LATCH

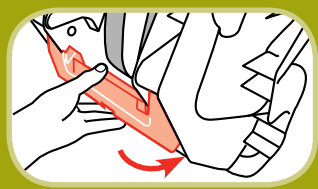

1. Fold the recline stand under the child restraint

⚠ WARNING:
Do not use the LATCH system along with the vehicle lap or lap/shoulder belt.
Check LATCH belt before each use. Use only if the belt can be tightened properly and securely.
Attach the top anchorage hook (tether) to recline stand when used rear-facing.
Failure to follow these warnings can result in serious injury or death.

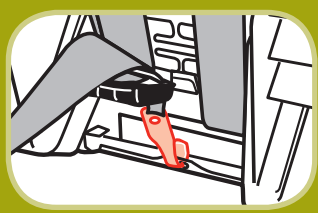

2. Store Top Anchorage Hook (Tether)
 Attach the top anchorage hook (tether) to recline stand as shown. Tighten tether to remove the slack.



3. Place Child Restraint in the Back Seat Rear-Facing
 Move the front seats forward to give you room to install the child restraint. With the child restraint in the fully reclined position, center the child restraint in the chosen seating position.

Note: Review your vehicle's owner manual for LATCH belt use.



4. Check for Proper Recline

For children between 5-22 lbs (2.3-10 kg), the bottom level to ground line **MUST** be level to the ground.

For children 22-40 lbs (10.1-18 kg) and can sit up unassisted, rotate the child restraint between the 2 level to ground lines. Start by making the bottom level to ground line level, then rotate seat up. **DO NOT** rotate past the top most upright level to ground line.

Adjust child restraint if needed.

You may need to place a large rolled towel(s) or foam pool noodle(s) **(A)** under the front of the child restraint to help achieve the correct recline. Check often to be sure padding is still in place and the LATCH belt is tight.

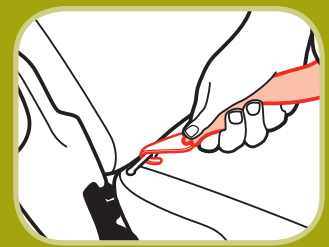
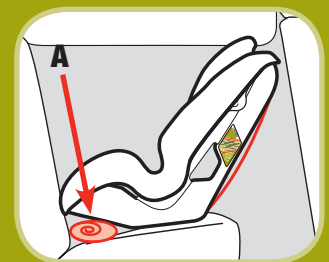

5. Hook LATCH to Vehicle Anchor

Fasten one LATCH belt hook to the anchor in the vehicle seat located in the vehicle seat bight. Repeat for other side of child restraint.

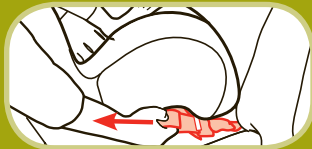

6. Tighten LATCH Belt

Push down firmly on the child restraint and pull up on the free end of LATCH belt to tighten.



It maybe easier to tighten the LATCH belt through the belt path opening as shown.

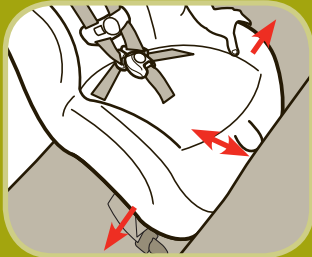

7. Check LATCH Belt Tightness

Grasp the child restraint at the belt path with one hand. Push and pull the child restraint from side to side, forward and back. The child restraint should not move more than 1 inch.

NOTE: If it moves more than an inch, try reinstalling the child restraint or try another seating location.

Secure your child in the child restraint. Recheck the recline angle to make sure it is reclined according to your child's weight. Repeat steps if not reclined correctly.

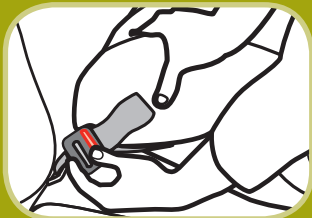

6. To Remove LATCH Belt From Vehicle Anchor

Remove child from child restraint. Press down firmly on adjuster side of child restraint and press release button to release tension. Unhook LATCH from bar by squeezing spring lever and twist hook (1). Pull LATCH hook away (2).

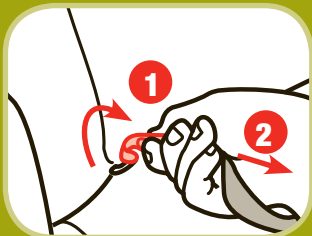

E-4 Install Rear-Facing with Vehicle Belts

⚠ WARNING:

Do not use the LATCH system along with the vehicle lap or lap/shoulder belt. Secure LATCH belts when using the vehicle belts.

Check the vehicle belt before each use. Use only if the belt is tightened properly and securely.

Attach the top anchorage hook (tether) to recline stand when used rear-facing.

Failure to follow these warnings can result in serious injury or death.

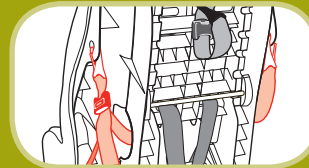

1. Secure LATCH Belts

You **MUST** fasten the LATCH belt hooks to the side of plastic shells as shown when using the vehicle seat belts.



2. Store Top Anchorage Hook (Tether)

Attach the top anchorage hook (tether) to recline stand as shown. Tighten tether to remove the slack.

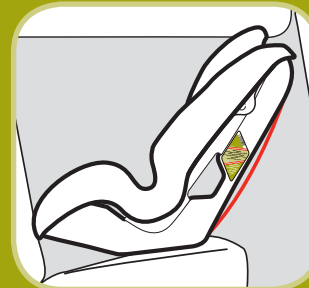

3. Place Child Restraint in the Back Seat Rear-Facing

Move the front seats forward to give you room to install the child restraint. With the child restraint in the fully reclined position, center the child restraint in the chosen seating position.

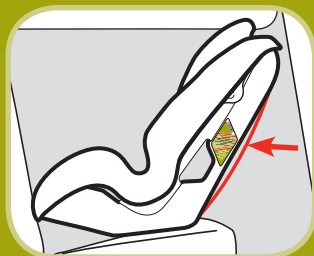

4. Check for Proper Recline

For children between 5-22 lbs (2.3-10 kg), the bottom level to ground line **MUST** be level to the ground.

For children 22-40 lbs (10.1-18 kg) and can sit up unassisted, rotate the child restraint between the 2 level to ground lines. Start by making the bottom level to ground line level, then rotate seat up. **DO NOT** rotate past the top most upright level to ground line.

Adjust child restraint if needed.

You may need to place a large rolled towel(s) or foam pool noodle(s) (A) under the front of the child restraint to help achieve the correct recline. Check often to be sure padding is still in place and the vehicle belt is tight.

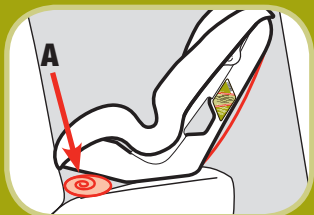

Note: Review the section D-4 to determine what kind of vehicle belts you have. Review your vehicle's owner manual for vehicle seat belt use.

5. Thread Vehicle Belt

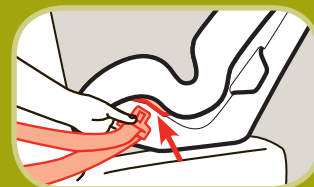

Thread the vehicle lap or lap/shoulder belt combination through the rear-facing belt path.

With an ALR vehicle belt, pull the vehicle belt all the way out before threading the child restraint.

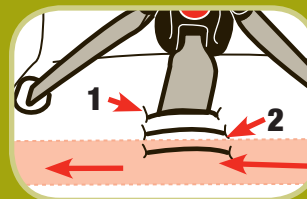

6. Pull Latch Plate Across to Opposite Side

Reach under pad and pull the vehicle belt across the plastic shell. Vehicle belt **MUST** be under pad and in front of buckle strap.

Do not place vehicle belt over child's legs.

NOTE: You must use the 1st or 2nd buckle strap slots when rear-facing.



7. Tighten Vehicle Belt

Push down firmly on the child restraint and pull on the vehicle shoulder belt to tighten.

It maybe easier to tighten the vehicle belt through the belt path opening as shown.



With a switchable retractor, pull the vehicle shoulder belt all the way out to switch the retractor into the ALR mode

before tightening. Feed the slack back into the retractor while tightening.

8. Check Vehicle belt Tightness

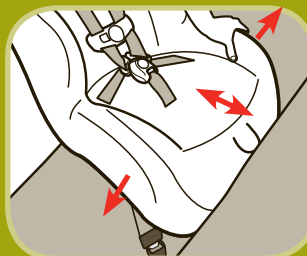

Grasp the child restraint at the belt path with one hand. Push and pull the child restraint from side to side, forward and back. The child restraint should not move more than 1 inch.

NOTE: If it moves more than an 1 inch, try reinstalling the child restraint or try another seating location.

Secure your child in the child restraint. Recheck the recline angle to make sure it is reclined according to your child's weight. Repeat steps if not reclined correctly.

F-1 Preparing to Install Forward-Facing 22-65 lbs (10.1-29 kg) and 34-52 in. (85.1-132.1 cm) and Over 1 Year Old. Forward-Facing using 5-point harness

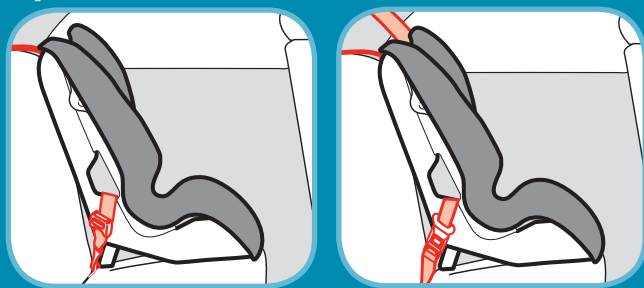

LATCH Belt



Lap/
Shoulder
Belt



Lap Belt

⚠ WARNING:

Never place a child less than one-year old or weighing less than 22 lbs. forward-facing.

Safety Tip:

Experts agree that children should remain rear-facing as long as possible. In this child restraint, your child can remain rear-facing up to 40 pounds and up to 40 inches.



F-2 Adjusting Top Anchorage Strap (Tether)

The top anchorage strap (tether) is used for the forward-facing position only.

Note: We strongly recommend that you use the top anchorage strap (tether) in the forward-facing position. If your vehicle does not have an anchor bracket, please see your dealer or a qualified mechanic and have one installed. The top anchorage strap (tether) can greatly improve the performance of this child restraint.

Storage of Top Anchorage Strap (Tether):

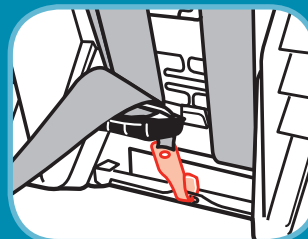

When the top anchorage strap (tether) is not in use, attach the top anchorage hook (tether) to recline stand as shown. Tighten tether to remove the slack.

To Adjust Top Anchorage Strap (tether):

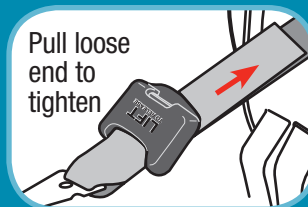

Pull loose
end to
tighten

To tighten; After the child restraint is locked into place with LATCH or vehicle belt, put knee in child restraint and push down. Pull on free end of top anchorage strap (tether).

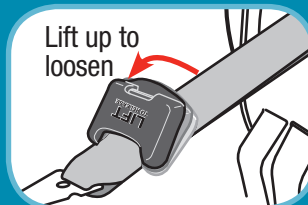

Lift up to
loosen

To loosen; Lift up on top anchorage lock and push lock toward top anchorage hook (tether).



F-3 Preparing to Install LATCH Forward-Facing



Note: Pull the LATCH belt out of the rear-facing belt path if you have used this child restraint rear-facing.

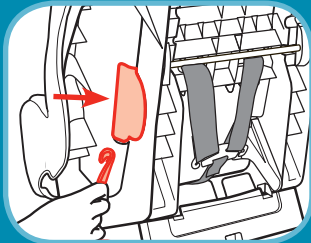

1. Routing LATCH Belt

Insert the hook without the adjuster closest to it, through the forward-facing belt path.

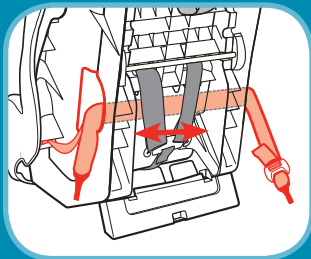

2. Thread LATCH Across

Pull the LATCH hook across the back and out the other side as shown. Do not twist the LATCH belt.



F-4 Install Forward-Facing With LATCH



Note: Review your vehicle's owner manual for LATCH belt use.

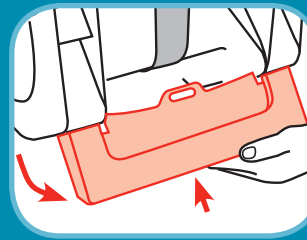

1. Child Restraint Must be Upright

Rotate recline stand out and push upward to lock in position.

⚠ WARNING:

Do not use the LATCH system along with the vehicle belt.

Check LATCH belt before each use. Use only if the belt can be tightened properly and securely.

Failure to follow these warnings can result in serious injury or death.



2. Place Child Restraint in the Back Seat Forward-Facing

Place child restraint **flush** against the vehicle seat back **forward-facing**.

Installation Tip:

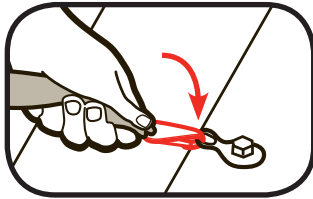

Loosely attach the tether hook before attaching the LATCH belt. Consult vehicle's owner manual for specific location.

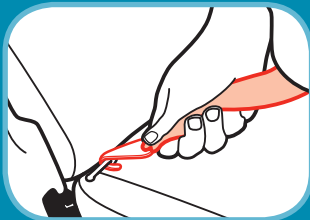

3. Hook LATCH to Vehicle Anchor

Fasten one LATCH belt hook to the anchor in the vehicle seat bight. Repeat for other side of child restraint.

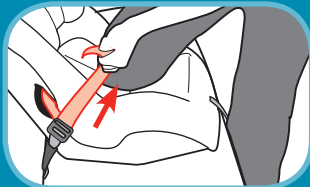

4. Tighten LATCH Belt

Place knee in the child restraint. Push down firmly while pulling up on the loop to tighten belt.

It may be easier to tighten the belt through the belt path opening as shown.

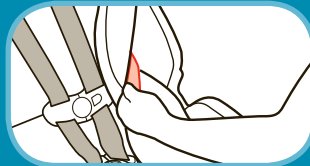

49

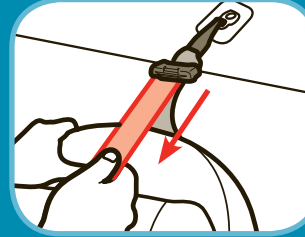

5. Tighten Top Anchorage Strap (Tether)

Push firmly on the back of the child restraint and tighten top anchorage strap (tether).

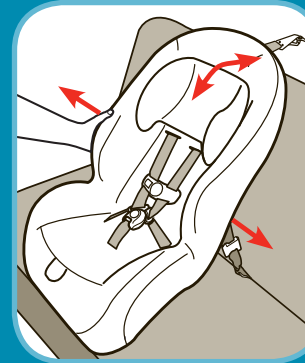

6. Check LATCH Belt Tightness

Grasp the child restraint at the belt path with one hand. Push and pull the child restraint from side to side, forward and back. The child restraint should not move more than 1 inch.

NOTE: If it moves more than an 1 inch, try

reinstalling the child restraint or try another seating location. Secure your child in the child restraint.

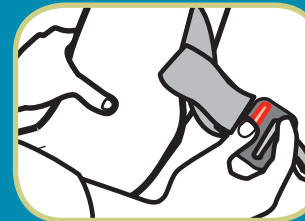

7. To Remove LATCH Belt From Vehicle Anchor

Remove child from child restraint. Press down firmly on adjuster side of child restraint and press release button to release tension. Unhook LATCH from bar by squeezing spring lever and twist hook (1). Pull LATCH hook away (2).

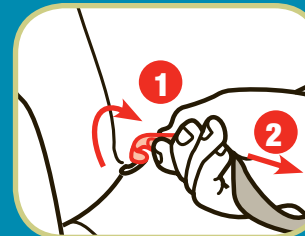

50



F-5 Install Forward-Facing With Vehicle Belts

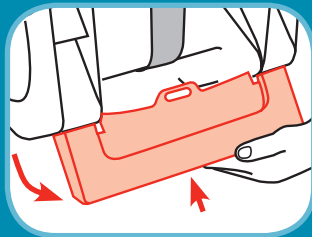

1. Child Restraint Must be Upright

Rotate recline stand out and push upward to lock in position.

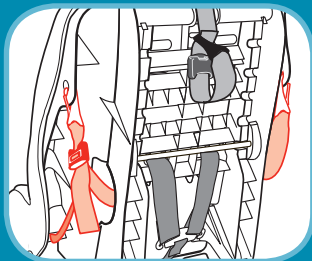

2. Secure LATCH Belts

You **MUST** fasten the LATCH belt hooks to the side of plastic shells as shown when using the vehicle seat belts.

⚠ WARNING:

Do not use the LATCH system along with the vehicle belt. Secure LATCH belts when using the vehicle belts.

Check the vehicle belt before each use. Use only if the belt is tightened properly and securely.

Failure to follow these warnings can result in serious injury or death.

Note: Review the section D-4 to determine what kind of vehicle belts you have. Review your vehicle's owner manual for vehicle seat belt use.

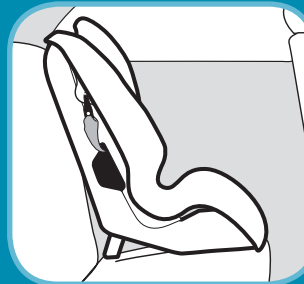

3. Place Child Restraint in Vehicle Forward-Facing

Place child restraint **flush** against the back of the vehicle seat **forward-facing** in the back seat.

Installation Tip:

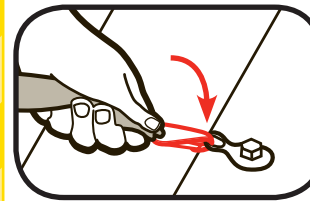

Loosely attach the top anchorage hook (tether) before threading the vehicle belt. Consult vehicle's owner manual for specific location.

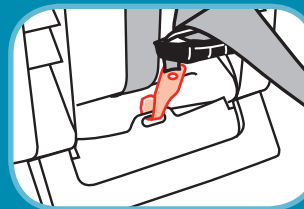

NOTE: If you cannot use the top anchorage strap (tether), attach the hook to the recline stand as shown. Tighten tether to remove the slack.

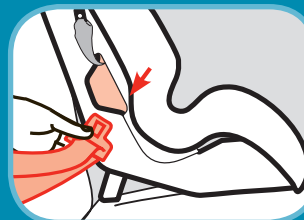

4. Thread Vehicle Belt

Thread the vehicle lap or lap/shoulder belt combination through the forward-facing belt slot and out the other side. Buckle vehicle belt.



5. Tighten Vehicle Belt

Push down firmly on the child restraint and pull on the vehicle shoulder belt or lap belt adjuster to tighten.

It may be easier to tighten the vehicle belt through the belt path opening as shown.

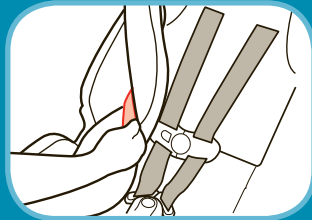

With a switchable retractor, pull the vehicle shoulder belt all the way out to switch the retractor into the ALR mode before tightening. Feed the slack back into the retractor while tightening.

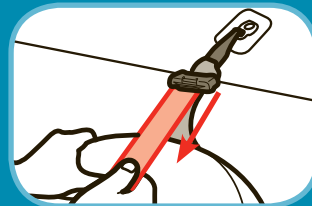

6. Tighten Top Anchorage Strap (Tether)

Push firmly on the back of the seat and tighten top anchorage strap (tether).

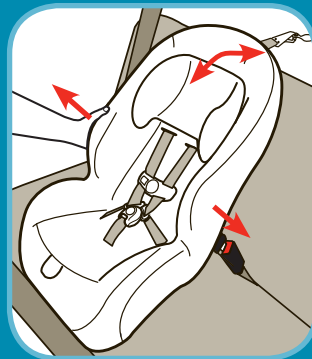

7. Check Vehicle Belt Tightness

Grasp the child restraint at the belt path with one hand. Push and pull the child restraint from side to side, forward and back. The child restraint should not move more than 1 inch.

NOTE: If it moves more than an 1 inch, try reinstalling the child restraint or try another seating location.

Secure your child in the child restraint.

Warranty

Dorel Juvenile Group, Inc. (DJG) warrants this product to the original retail purchaser as follows:

This product is warranted against defective materials or workmanship for one year from the date of original purchase. **An original receipt is required to validate your warranty.** DJG will, at its option, provide replacement parts or replace this product. DJG reserves the right to substitute if the part or model has been discontinued.

To make a claim under this warranty you may contact us at www.djgusa.com, fax us at 1-800-207-8182 24 hours a day, write to DJG, Consumer Relations Department, P. O. Box 2609, Columbus, IN 47202-2609, or call 1-800-544-1108 from 7:00 a.m. to 6:00 p.m. EST Monday through Thursday and from 7:00 a.m. to 4:30 p.m. on Friday. **Proof of purchase is required and shipping charges are the responsibility of the consumer.**

Warranty Limitations:

This warranty does not include damages which arise from misuse or abuse of this product.

Limitation of Damages:

The warranty and remedies as set forth are exclusive and in lieu of all others, oral or written, expressed or implied. In no event will DJG or the dealer selling this product be liable to you for any damages, including incidental or consequential damages, arising out of the use or inability to use this product.

Limitation of warranties and other warranty terms and state law rights:

Any implied warranties, including implied warranties of the merchantability and fitness for a particular purpose, shall be limited to the duration and terms of the express written warranty. Some states do not allow limitations as to how long an implied warranty lasts or the exclusion or limitation of incidental or consequential damages, so the above limitations may not apply to you. This warranty gives you specific legal rights, and you may have other rights, which vary from state to state. Neither DJG nor the dealer selling this product authorized any person to create for it any other warranty, obligation, or liability in connection with this product.

PLEASE COMPLETE AND MAIL THE PRE-ADDRESSED OWNER REGISTRATION CARD WITHIN (30) DAYS OF PURCHASE TO EXPEDITE WARRANTY CLAIMS AND TO VERIFY THE ORIGINAL DATE OF PURCHASE.

Trouble Shooting

- 1. If the child restraint buckle or harness release lever sticks or you cannot get the straps tight enough around child:** DO NOT LUBRICATE. Check around lever and retractor for dropped food, sticky spilled drinks, dirt, leaves, etc. Clean with warm water and/or remove object with tweezers. If you cannot get the harness to adjust and remain tight with the buckle securely locked, do not use the child restraint.
- 2. If your harness twists:** Straighten the harness each time you put your child in the child restraint to help prevent twisting. Lock the buckle and tighten harness and it will be ready for next use.
- 3. If your infant sits too upright in the rear-facing position:** If your vehicle seat slopes so much that your infant is sitting

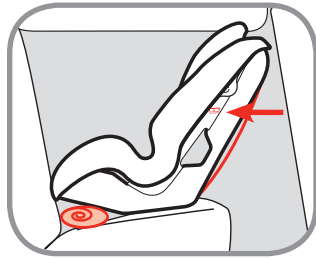

upright, you may place a rolled towel(s) or foam pool noodle(s) under the front of the child restraint so that the level line on the side of the plastic shell is level (horizontal). Check often to be sure padding is still in place and the vehicle belt is tight.

- 4. Locate a Child Safety Seat Inspection Station for hands on training on how to use your child restraint:** Visit your local Child Passenger Inspection Station or go to <http://www.nhtsa.dot.gov/cps/cpsfitting/index.cfm> to find your closest station.

⚠ WARNING:

Using padding that tilts the child restraint farther back than the level-to-ground line can result in serious injury or death.

Replacement Parts Order Form

Complete the form below. Your model number with color code and manufacturer date code MUST be included on the form to ensure proper replacement parts. Your model number with color code and the date code can be found on a sticker on the side of child restraint. Payment in U.S. dollars must accompany your order. Choose parts needed from the list on the next page.

Return the form with payment to:

Dorel Juvenile Group, Inc.
Consumer Relations Department
P.O. Box 2609
Columbus, IN 47202-2609

Fax orders to: 1-800-207-8182

Please make money orders payable to Dorel Juvenile Group, Inc. Fill in the area below to charge to Visa or Mastercard. We do not accept personal checks or Discover Card. All outside of U.S. and Canada MUST use credit card.

Ship To (Please Print): _____

Name: _____

Address: _____

City: _____

State/Province: _____ Zip _____

Telephone: _____

Email Address: _____

We MUST have this information to process your order:

Model Number (8 to 9 characters): _____

Manufacture Date (mm/dd/yyyy): _____

Replacement Parts List

NOTE: If requested color is not available, similar color will be substituted. Prices are subject to change.

Part	Cost	Quantity	Total Cost
Buckle Strap/Buckle....	\$4.99	X _____	= \$ _____
Harness Strap	\$2.00	X _____	= \$ _____
Pad for Plastic Shell .	\$32.99	X _____	= \$ _____
Chest Clip.....	\$1.50	X _____	= \$ _____
Locking Clip	\$2.50	X _____	= \$ _____
Tether Kit	\$9.99	X _____	= \$ _____
Latch Kit.....	\$24.99	X _____	= \$ _____
Instructions	\$0.00	X _____	= \$ _____

Merchandise Total \$ _____

Shipping and handling: \$ _____

Up to \$25.00.....	\$5.95	\$150.01 to \$200.00	\$11.95
\$25.01 to \$50.00	\$6.95	\$200.01 and up	\$13.95
\$50.01 to \$75.00	\$8.95		
\$75.01 to \$100.00	\$9.95	Outside Continental USA	\$10.00
\$100.01 to \$150.00	\$10.95		

Sales Tax \$ _____
 (Indiana, California, and Massachusetts residents add applicable sales tax.)

Grand Total \$ _____

No shipping and handling on instructions for quantities under 6. Add \$.50 for each instruction over 6, then add applicable shipping and handling.

CUT ON DOTTED LINE

Fill Out For Credit Card

Visa Mastercard

Card Exp. Date: _____

Cardholder's Name: _____

Card Number: _____

Signature _____